



## Anti shock air valve for high-rise buildings and pumping stations Mod. FOX 3F - HR

The CSA air valve Mod. FOX 3F-HR will ensure the proper operation of the system allowing the release of air pockets during working conditions, the entrance of large volumes of air during draining operations and pipeline bursts and the air discharge with controlled speed, to prevent water hammer.



### Technical features and benefits

- Body in ductile cast iron, PN 40 bar rated, provided with internal ribs for consistent and accurate guiding of the mobile block.
- Drainage valve produced by CSA, for chamber control and pressure relief during maintenance.
- Mobile block composed of a cylindrical float and upper disk in solid polypropylene, joined together by the CSA air release system in AISI 316 (patent pending).
- Nozzle and gasket holder, part of CSA air release system, entirely made in AISI 316 and designed with gasket compression control to prevent aging process and consequent leakage during working conditions.
- Anti water hammer system (also called AS function), never in contact with water, obtained by a spring and shaft in stainless steel, disk with adjustable sonic nozzles for air flow control.
- Threaded outlet elbow to avoid spray effect, conveying spurts coming from the closure away from the valve. This feature will also allow the proper operation in case of flood, without the risk of contaminated water entering the pipeline.
- FOX HR can be provided on request with an optional Y strainer to prevent solids and debris from reaching its upper part where the air release system and the sealing seat are located.

### Applications

- Pipeline risers.
- High-rise buildings.
- Irrigation and treated water pumping stations.

## Operating principle

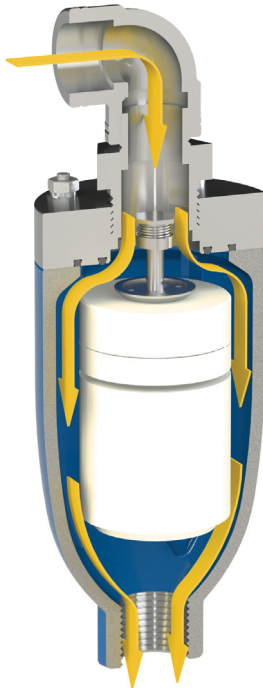

### Entrance of large volumes of air

During pipeline draining, or pipe bursts, it is necessary to bring in as much air as the quantity of outflowing water to avoid negative pressure and serious damages of the pipeline, and to the entire system.

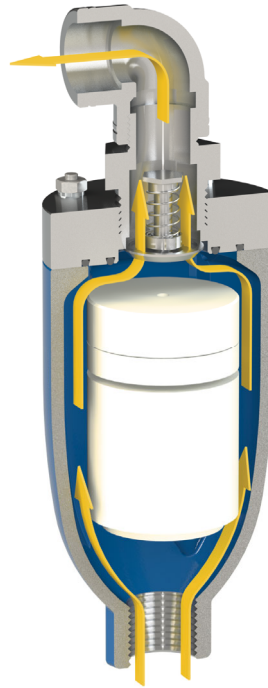

### Controlled air discharge

During the pipe filling it is necessary to avoid rapid closures, responsible of water hammer effects. The FOX-3F-HR, thanks to the anti-shock feature, will control the air outflow thus reducing the velocity of the approaching water column. The risk of overpressure will therefore be minimized.

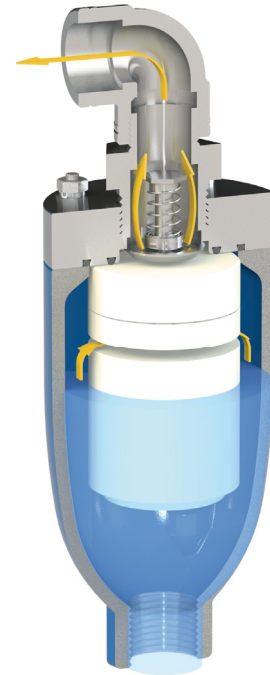

### Air release during working conditions

During operation the air produced by the pipeline is accumulated in the upper part of the air valve. Little by little it is compressed and the pressure arrives to water pressure, therefore its volume increases pushing the water level downwards allowing the air release through the nozzle.

## Installation



Some example of applications are depicted in the picture A and B. The first showing the installation on a vertical riser typical of a high rise building and plants. On the second image the air valve is located before and after the check valve of a pump to allow for the controlled air discharge during pump start and air release in working conditions. We strongly advise to check and guarantee a minimum working pressure in order to avoid leakage, that can happen especially with high rise applications in dynamic conditions.



- 1- Pressure reducing valve XLC 310/410
- 2- Relief valve VSM or VSM FF
- 3- Anti-slam air valve FOX-3F-HR

## Technical data

### Air valve selection chart

Range of application of the air valve as a function of pipeline internal diameter and fluid flow velocity expressed in m/s.

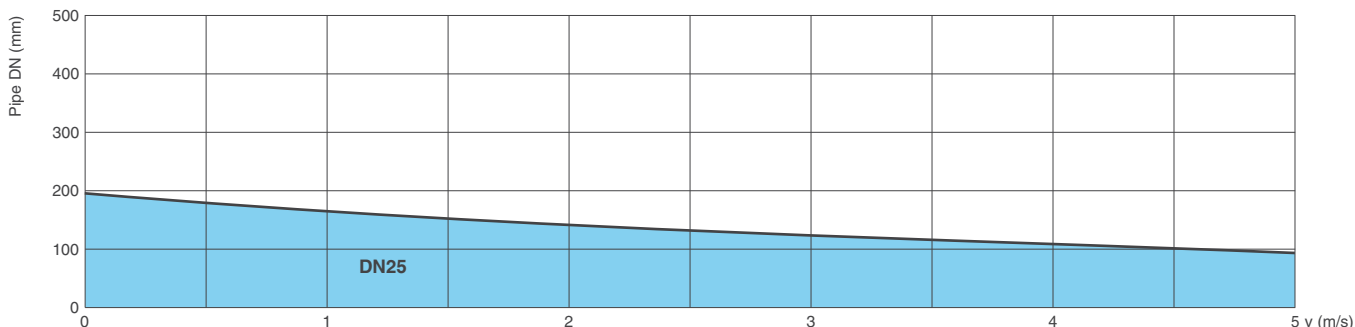

### Air flow performance charts

AIR ENTRANCE DURING PIPE DRAINING

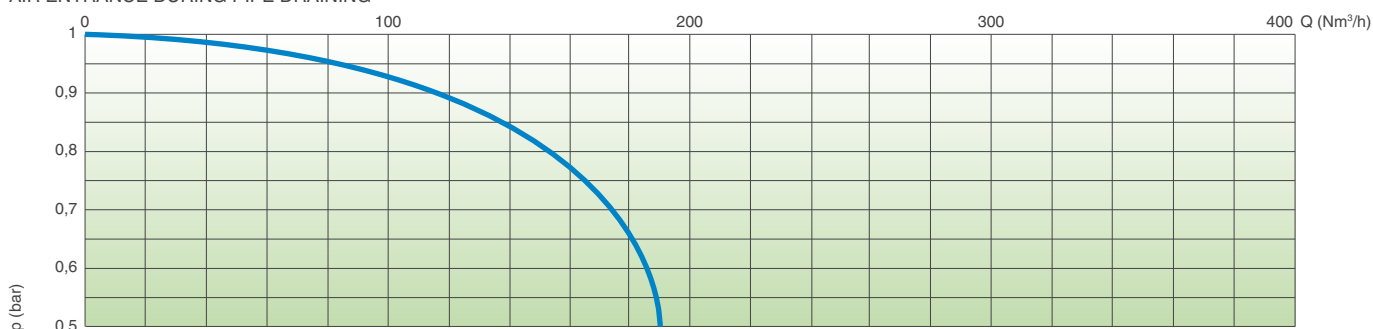

The air flow charts were created in Kg/s from laboratory tests and numerical analysis, then converted in Nm<sup>3</sup>/h using a safety factor.

### Working conditions

Treated water max. 60°C.  
Max. pressure 40 bar.  
Min. pressure 0,2 bar.

### Standard

Designed in compliance with EN-1074/4 and AWWA C-512.  
Epoxy painting applied through fluidized bed technology blue RAL 5005. Standard threads BSP.  
Changes on painting and threads available on request.

AIR RELEASE DURING WORKING CONDITIONS  
nozzle diameter (mm)

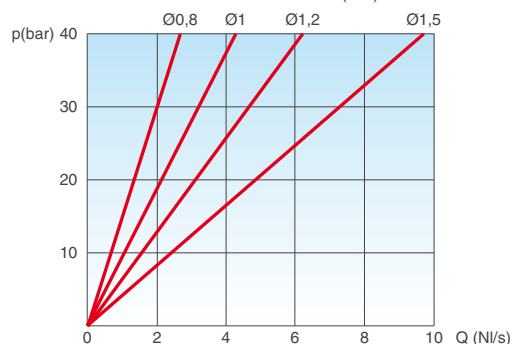

### Nozzle choice

Nozzle diameter in mm according to the PN of the air valve.

PN 10	PN 16	PN 25	PN 40
1,5	1,2	1	0,8

### Weights and dimensions

A inch	B inch	C mm	D mm	E mm	Weight Kg
1"	1"	~325	105	70	3,2

DN 2", flanged and larger size available on request.

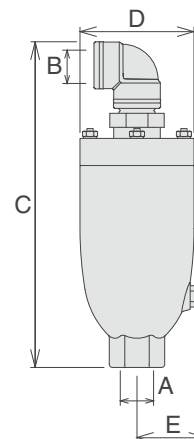

## Technical details

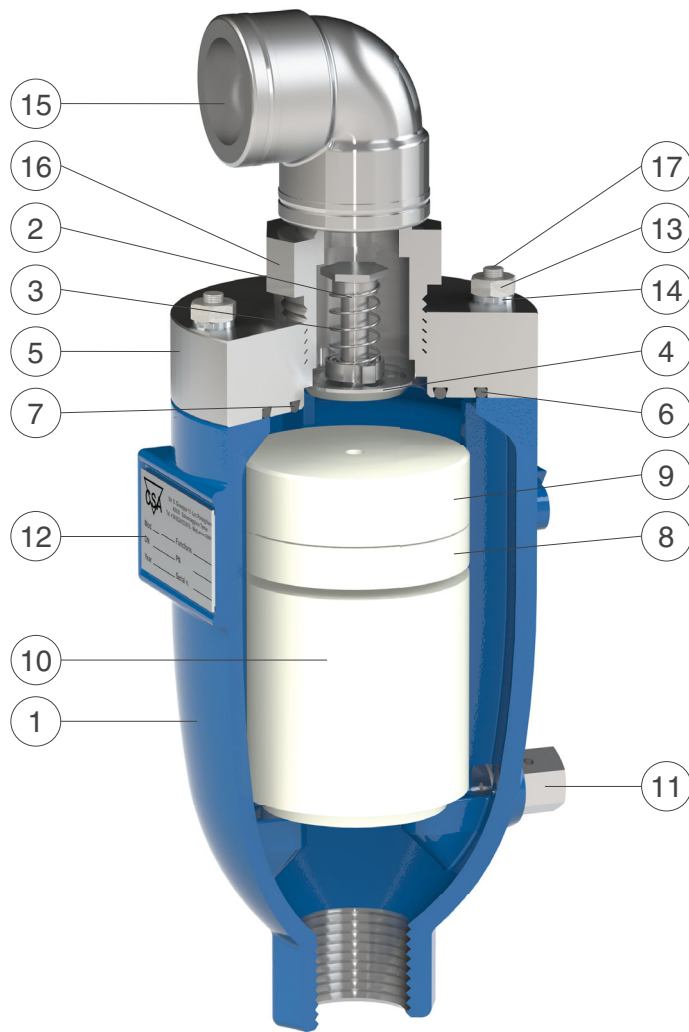

Available version with threaded elbow in polypropylene.

N.	Component	Standard material	Optional
1	Body	ductile cast iron GJS 450-10	
2	AS shaft	stainless steel AISI 304	stainless steel AISI 316
3	AS spring	stainless steel AISI 302	
4	AS flat	stainless steel AISI 304	stainless steel AISI 316
5	HR seat	stainless steel AISI 304	stainless steel AISI 316
6	O-ring	NBR	EPDM/Viton/silicone
7	O-ring	NBR	EPDM/Viton/silicone
8	Upper flat with nozzle subset	polypropylene and stainless steel AISI 316	
9	RFP flat with O-ring	polypropylene and NBR	EPDM/Viton/silicone
10	Float	polypropylene	
11	Drain valve	stainless steel AISI 304	stainless steel AISI 316
12	Tag	stainless steel AISI 304	
13	Nuts	stainless steel AISI 304	stainless steel AISI 316
14	Washer	stainless steel AISI 304	stainless steel AISI 316
15	Threaded elbow 1"	stainless steel AISI 304/316	polypropylene
16	Fitting 1" 1/4 - 1"	stainless steel AISI 304/316	polypropylene
17	Threaded studs	stainless steel AISI 304	stainless steel AISI 316